



**CHONGQING CLOUDCHILD TECHNOLOGY CO.,LTD**  
**TO-252-2L Plastic-Encapsulate MOSFETS**

**CCMC15P06T**      **P-Channel Power MOSFET**

$V_{(BR)DSS}$	$R_{DS(on)TYP}$	$I_D$
-60 V	60mΩ@-10V	-15A
	78mΩ@-4.5V	

**DESCRIPTION**

The CCMC15P06T uses advanced trench technology and design to provide excellent  $R_{DS(ON)}$  with low gate charge. It can be used in a wide variety of applications .

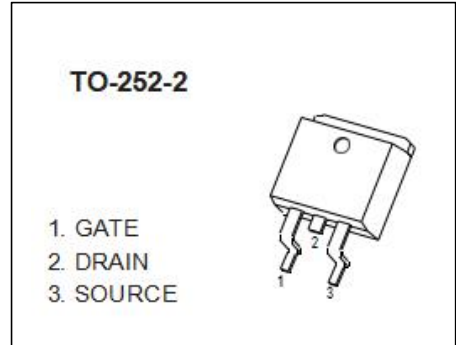

**FEATURES**

- TrenchFET® Power MOSFET
- 100% Rg and UIS Tested
- AEC Q101 qualified

**APPLICATIONS**

- PLC field
- High-frequency switching

**MARKING**



CCMC15P06T =Part No.  
 XXXXXXX = Code.

**EQUIVALENT CIRCUIT**

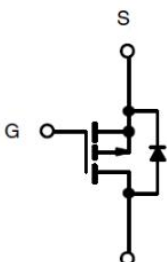

**ABSOLUTE MAXIMUM RATINGS( $T_c=25^{\circ}\text{C}$  unless otherwise noted)**

Parameter	Symbol	Limit	Unit
Drain-Source Voltage	$V_{DS}$	-60	V
Gate-Source Voltage	$V_{GS}$	$\pm 20$	V
Continuous Drain Current <sup>1</sup>	$I_D$	-15	A
Pulsed Drain Current <sup>2</sup>	$I_{DM}$	-60	A
Single Pulse Avalanche Energy <sup>3</sup>	EAS	56	mJ
Total Power Dissipation <sup>1</sup>	$P_D$	54	W
Thermal Resistance from Junction to Case <sup>1</sup>	$R_{\theta JC}$	2.8	$^{\circ}\text{C}/\text{W}$
Operating Junction and Storage Temperature Range	$T_J, T_{STG}$	-55~ +175	$^{\circ}\text{C}$
Soldering Temperature , for 10S(1.6mm from case)	-	260	$^{\circ}\text{C}$

**Notes:**

1.  $T_c=25^{\circ}\text{C}$  Limited only by maximum temperature allowed.
2.  $P_w \leq 10\mu\text{s}$ , Duty cycle  $\leq 1\%$ .
3. EAS condition:  $V_{DD}=20\text{V}, V_{GS}=-10\text{V}, I_D=-15\text{A}, L=0.5\text{mH}, R_g=25\Omega$ , Starting  $T_J = 25^{\circ}\text{C}$ .

# MOSFET ELECTRICAL CHARACTERISTICS

TC=25°C unless otherwise specified

Parameter	Symbol	Test Condition	Min	Typ	Max	Unit
<b>Off characteristics</b>						
Drain-source breakdown voltage	$V_{(BR)DSS}$	$V_{GS} = 0V, I_D = -250\mu A$	-60			V
Zero gate voltage drain current	$I_{DSS}$	$V_{DS} = -48V, V_{GS} = 0V$			-1	$\mu A$
Gate-body leakage current	$I_{GSS}$	$V_{DS} = 0V, V_{GS} = \pm 20V$			$\pm 100$	nA
<b>On characteristics<sup>4</sup></b>						
Gate-threshold voltage	$V_{GS(th)}$	$V_{DS} = V_{GS}, I_D = -250\mu A$	-1.5	-2.0	-3.0	V
Static drain-source on-state resistance	$R_{DS(on)}$	$V_{GS} = -10V, I_D = -10A$		60	80	m $\Omega$
		$V_{GS} = -4.5V, I_D = -10A$		78	120	m $\Omega$
Forward transconductance	$g_{fs}$	$V_{DS} = -10V, I_D = -10A$		18		S
<b>Dynamic characteristics<sup>34</sup></b>						
Input capacitance	$C_{iss}$	$V_{DS} = -25V, V_{GS} = 0V,$ $f = 1MHz$		1115		pF
Output capacitance	$C_{oss}$			70		
Reverse transfer capacitance	$C_{rss}$			62		
Gate resistance	$R_g$	$f = 1MHz$		6.5		$\Omega$
<b>Switching characteristics<sup>34</sup></b>						
Total gate charge	$Q_g$	$V_{GS} = -4.5V, V_{DD} = -30V,$ $I_D = -3.1A$			12	nC
Gate-source charge	$Q_{gs}$			2.2		
Gate-drain charge	$Q_{gd}$			3.7		
Turn-on delay time	$t_{d(on)}$	$V_{DD} = -30V, I_D = -$ $2.4A, V_{GS} = -4.5V,$ $R_G = 1\Omega$		45		ns
Turn-on rise time	$t_r$			102		
Turn-off delay time	$t_{d(off)}$			60		
Turn-off fall time	$t_f$			45		
<b>Drain-Source Diode Characteristics</b>						
Drain-source diode forward voltage <sup>4</sup>	$V_{SD}$	$V_{GS} = 0V, I_S = -20A$			-1.6	V
Continuous drain-source diode forward Current <sup>1</sup>	$I_S$	-			-15	A
Pulsed drain-source diode forward current <sup>2</sup>	$I_{SM}$	-			-60	A
Reverse recovery time	$T_{rr}$	$I_F = -15A, di/dt = 100A/us$		52		ns
Reverse recovery charge	$Q_{rr}$			102		nC

Note :

1.  $T_C = 25^\circ C$  Limited only by maximum temperature allowed.
2.  $P_W \leq 10\mu s$ , Duty cycle  $\leq 1\%$ .
3. Guaranteed by design, not subject to production.
4. Pulse Test : Pulse Width  $\leq 300\mu s$ , duty cycle  $\leq 2\%$ .

# Typical Characteristics

PD -- Tc

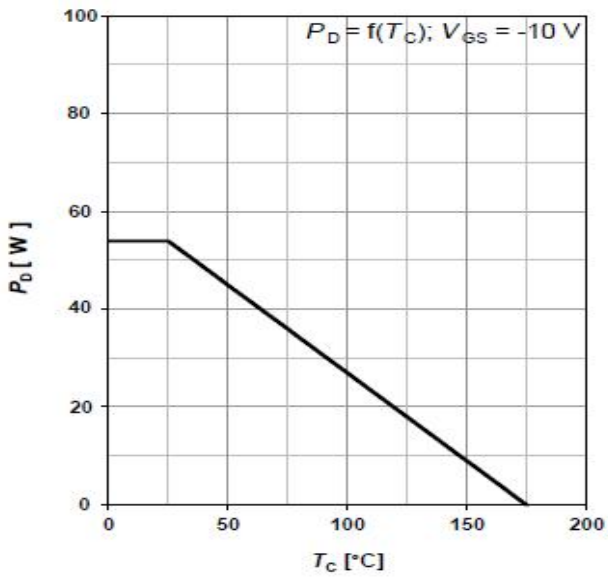

ID -- Tc

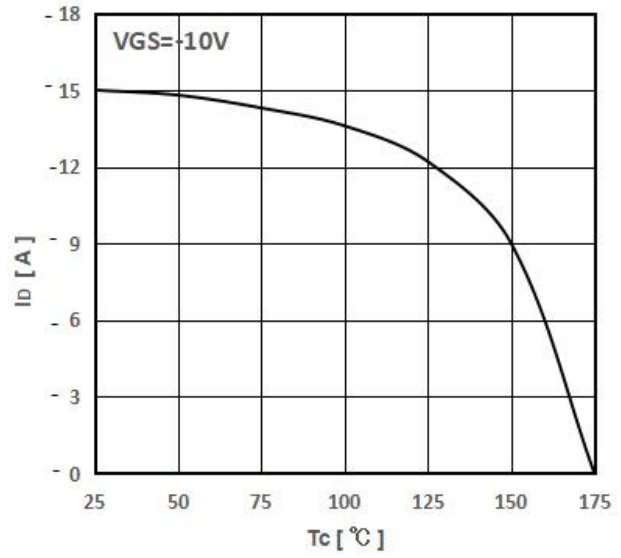

ID -- VDS

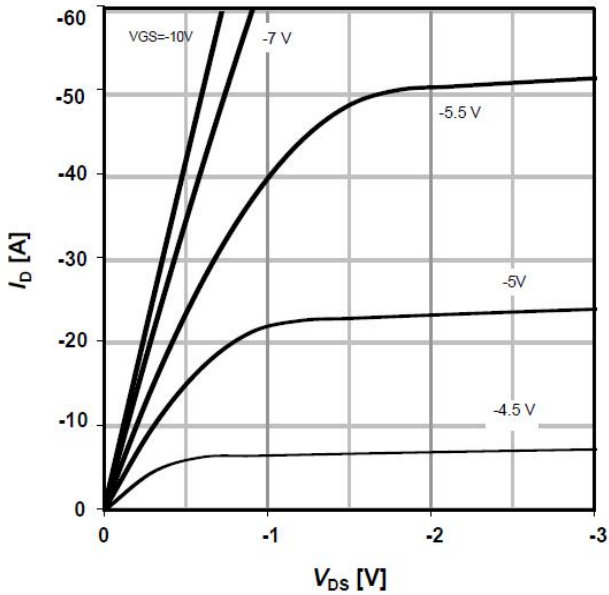

ID -- VGS

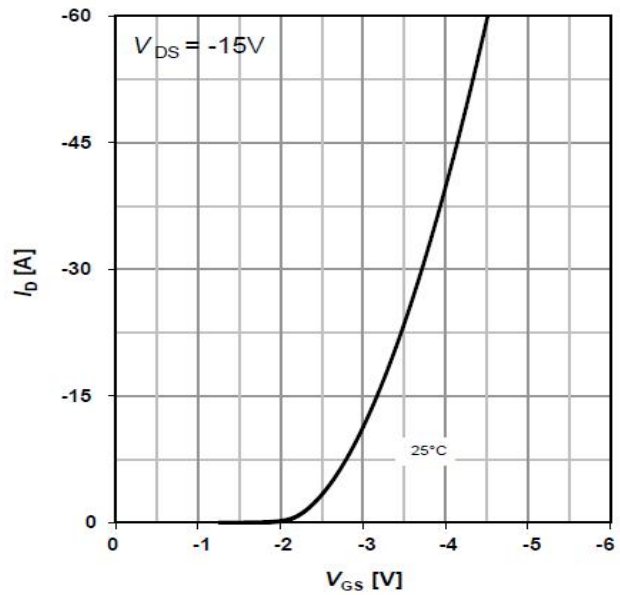

RDS(on) -- ID

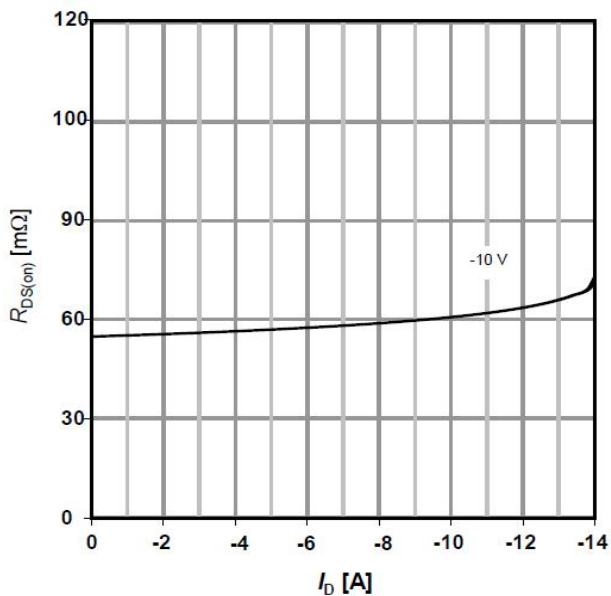

IS -- VSD

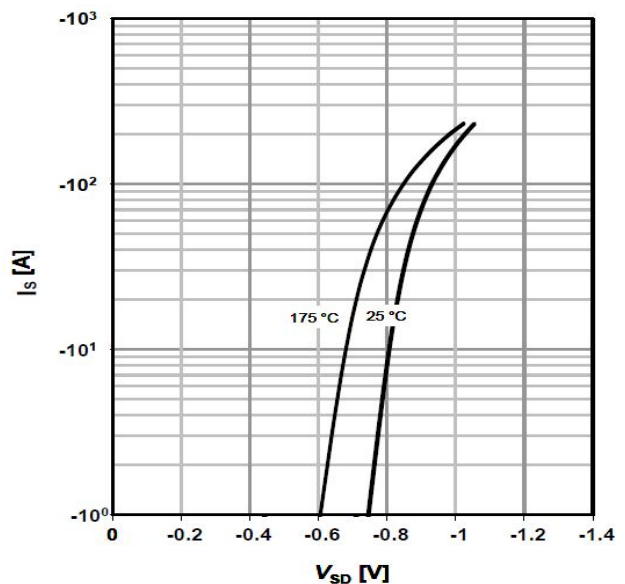

**RDS(on) -- VGS**

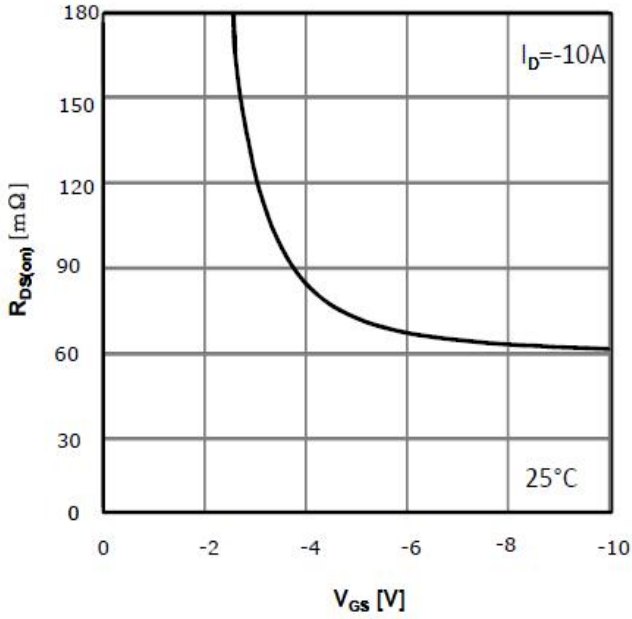

**Threshold Voltage**

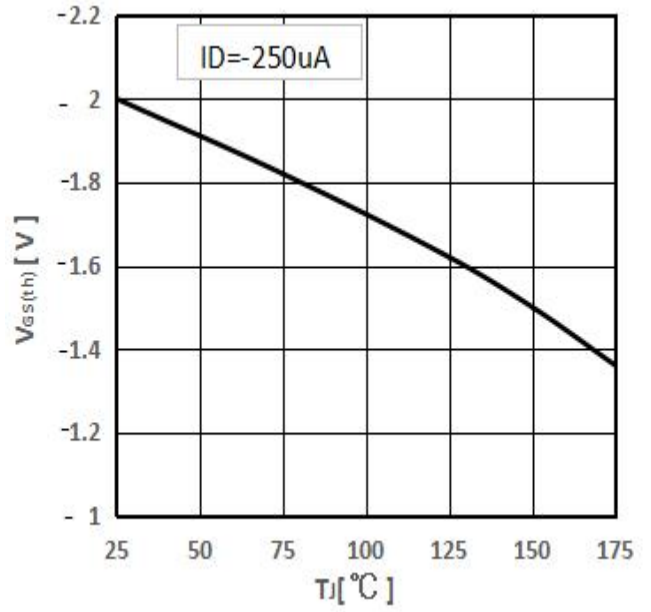

**Drain-source breakdown voltage**

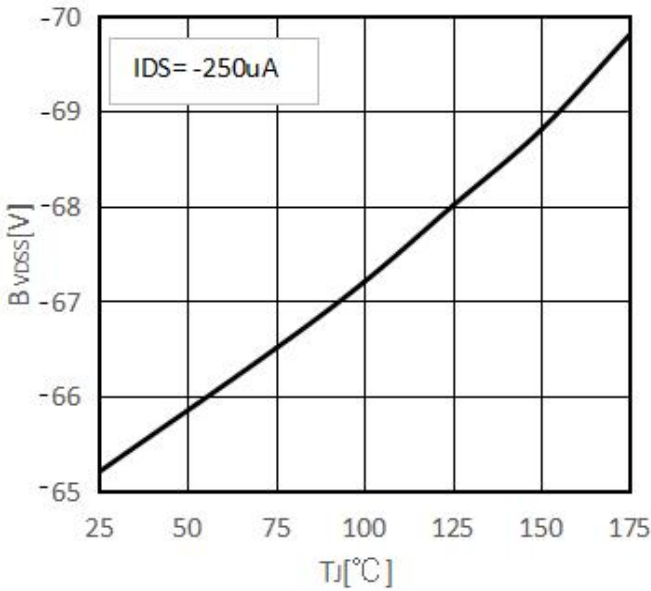

**RDS (on) -- TJ**

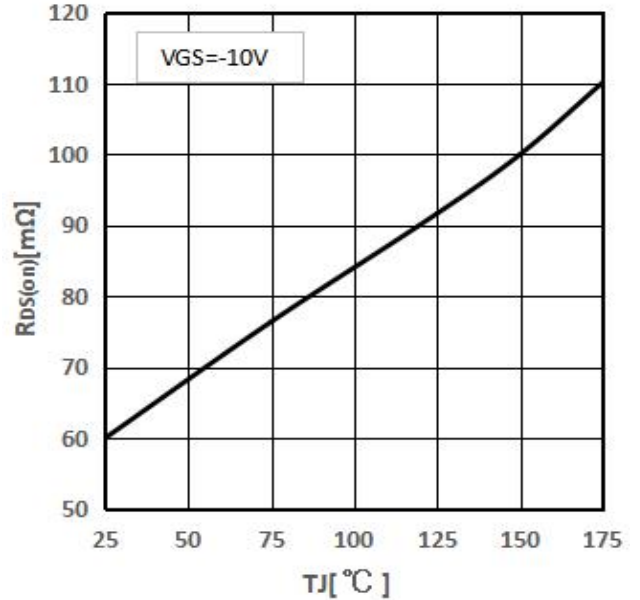

**Typ.gate charge**

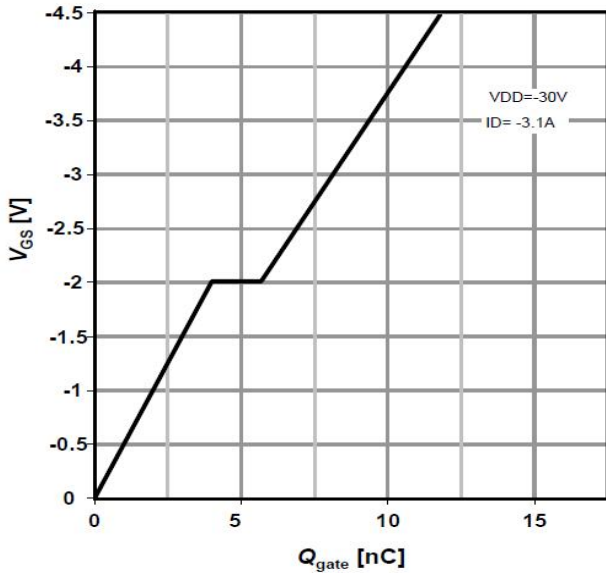

**Avalanche energy**

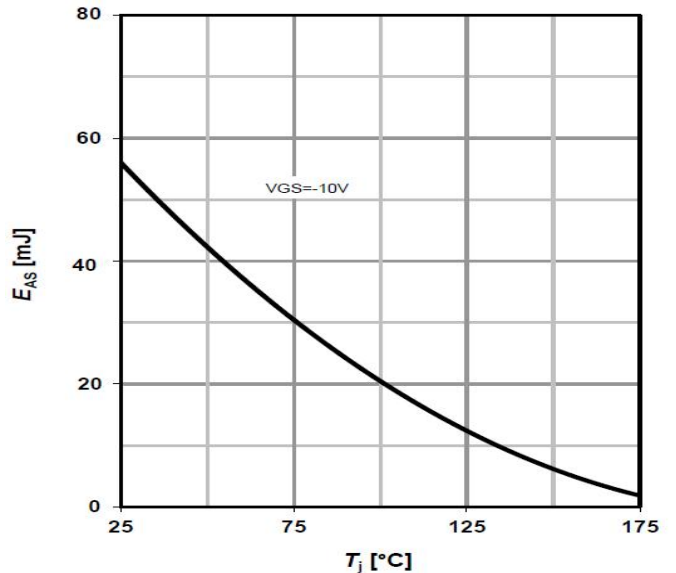

Typ. capacitance

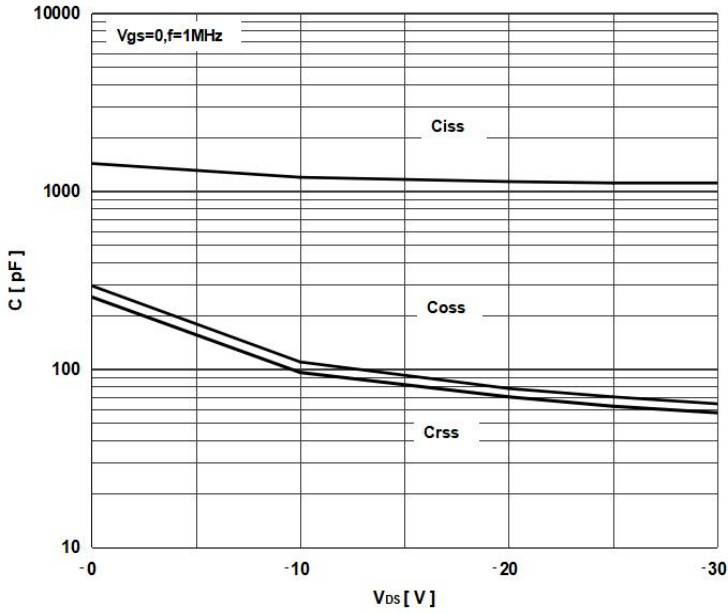

Gate charge waveforms

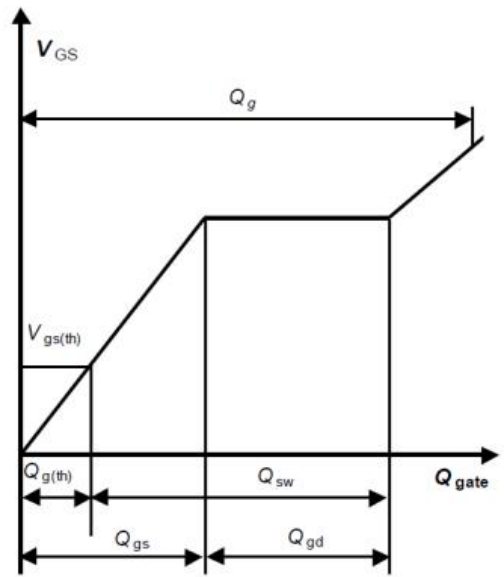

Maximum Forward Biased Safe Operating Area

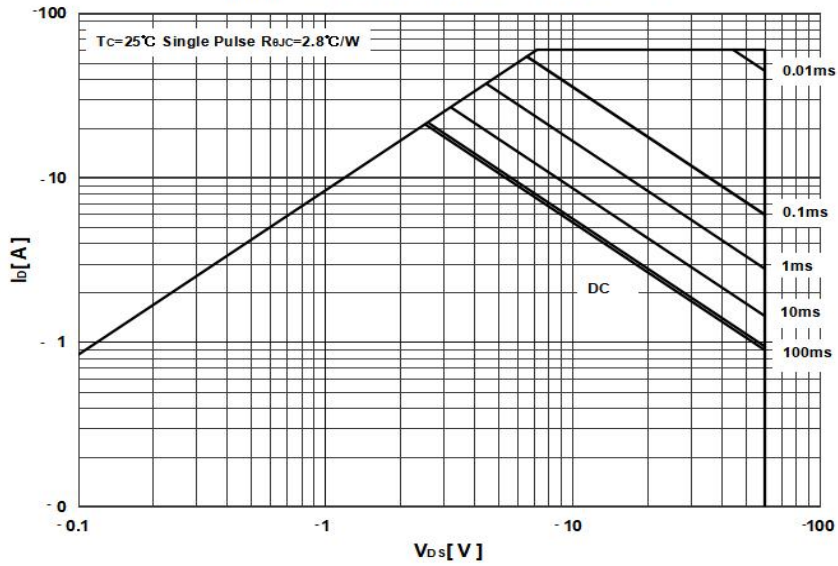

Normalized Thermal Transient Impedance

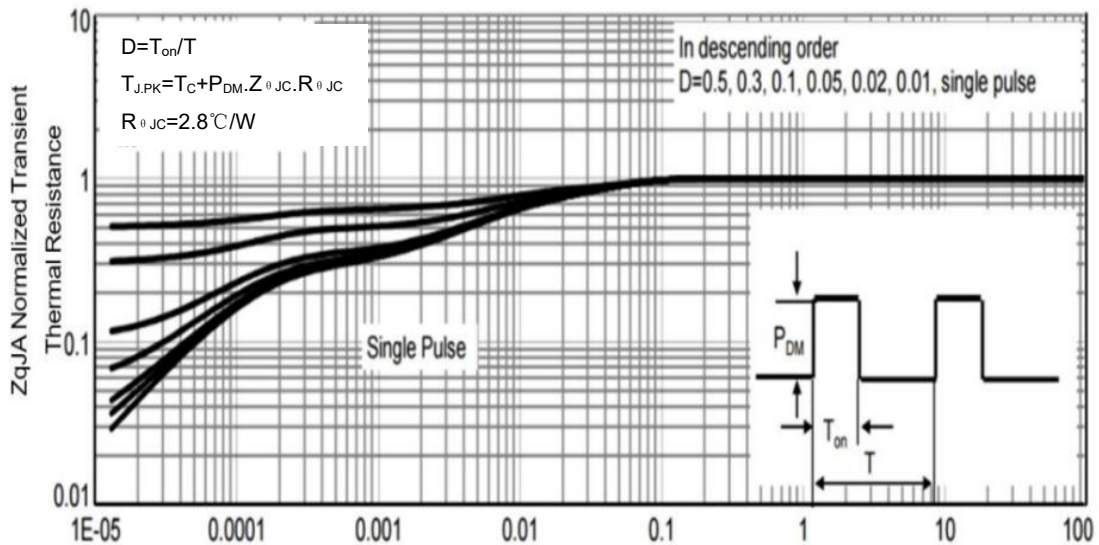

## TO-252-2L Package Outline Dimensions

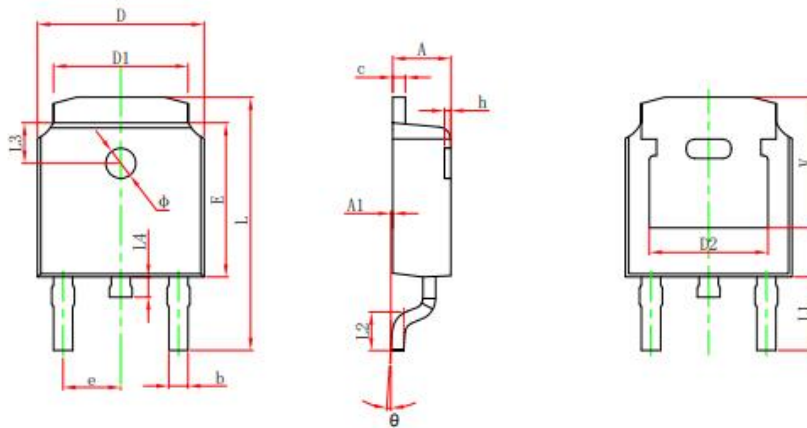

Symbol	Dimensions In Millimeters		Dimensions In Inches	
	Min.	Max.	Min.	Max.
A	2.200	2.400	0.087	0.094
A1	0.000	0.127	0.000	0.005
b	0.635	0.770	0.025	0.030
c	0.460	0.580	0.018	0.023
D	6.500	6.700	0.256	0.264
D1	5.100	5.460	0.201	0.215
D2	4.830 REF.		0.190 REF.	
E	6.000	6.200	0.236	0.244
e	2.186	2.386	0.086	0.094
L	9.712	10.312	0.382	0.406
L1	2.900 REF.		0.114 REF.	
L2	1.400	1.700	0.055	0.067
L3	1.600 REF.		0.063 REF.	
L4	0.600	1.000	0.024	0.039
Φ	1.100	1.300	0.043	0.051
θ	0° - 8°		0° - 8°	
h	0.000	0.300	0.000	0.012
V	5.250 REF.		0.207 REF.	

## TO-252-2L Suggested Pad Layout

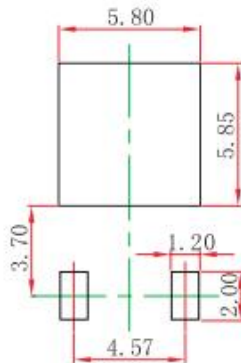

Note:

1. Controlling dimension: in millimeters.
2. General tolerance: 0.5mm.
3. The pad layout is for reference purposes only.

### NOTICE

Cloudchild reserve the right to make modifications, enhancements, improvements, corrections or other changes without further notice to any product herein. Cloudchild does not assume any liability arising out of the application or use of any product described herein.

ChongQing Cloudchild Technology Co., Ltd. (short for Cloudchild) exerts the greatest possible effort to ensure high quality and reliability. Nevertheless, semiconductor devices in general can malfunction or fail due to their inherent electrical sensitivity and vulnerability to physical stress. It is the responsibility of the buyer, when utilizing Cloudchild products, to comply with the standards of safety in making a safe design for the entire system, including redundancy, fire-prevention measures, and malfunction prevention, to prevent any accidents, fires, or community damage that may ensue. In developing your designs, please ensure that Cloudchild products are used within specified operating ranges as set forth in the most recent Cloudchild products specifications.

## TO-252-2L Tape and Reel

### TO-252 Embossed Carrier Tape

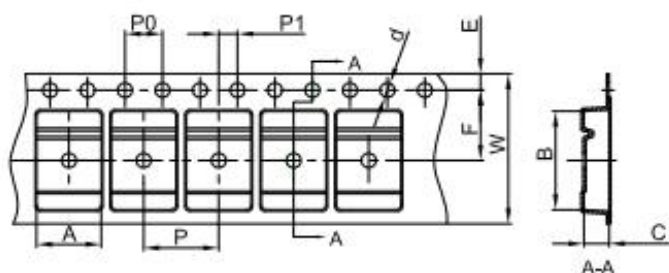

#### Packaging Description:

TO-252 parts are shipped in tape. The carrier tape is made from a dissipative (carbon filled) polycarbonate resin. The cover tape is a multilayer film (Heat Activated Adhesive in nature) primarily composed of polyester film, adhesive layer, sealant, and anti-static sprayed agent. These reeled parts in standard option are shipped with 25,00 units per 13" or 33.0 cm diameter reel. The reels are clear in color and is made of polystyrene plastic (anti-static coated).

Dimensions are in millimeter										
Pkg type	A	B	C	d	E	F	P0	P	P1	W
TO-252	6.90	10.50	2.70	Ø1.55	1.75	7.50	4.00	8.00	2.00	16.00

### TO-252 Tape Leader and Trailer

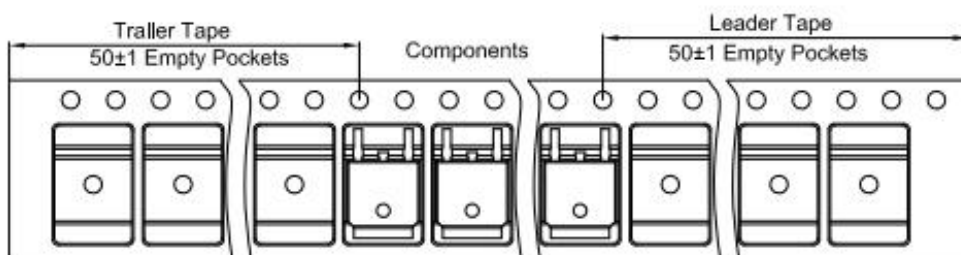

### TO-252 Reel

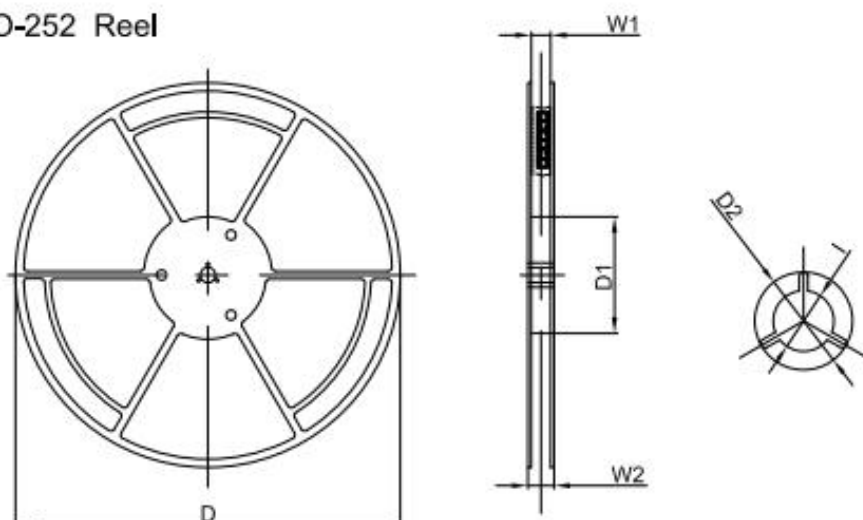

Dimensions are in millimeter						
Reel Option	D	D1	D2	W1	W2	I
13" Dia	330.00	100.00	Ø21.00	16.40	21.00	Ø13.00

REEL	Reel Size	Box	Box Size(mm)	Carton	Carton Size(mm)	G.W.(kg)
2,500 pcs	13Inch	2,500 pcs	340×336×29	25,000 pcs	353×346×365	



Date of change	Rev #	revise content
2022/12/13	A/0	/